

# SAFETY HINTS

## 1. BEFORE OPERATING THE MACHINE

Think-safety first.

In special situation, wear protective clothing including a safety helmet, safety shoes, gloves, safety glasses and ear protection as required by the job condition.

Almost every accident is caused by disregarding the simple and fundamental safety hints.

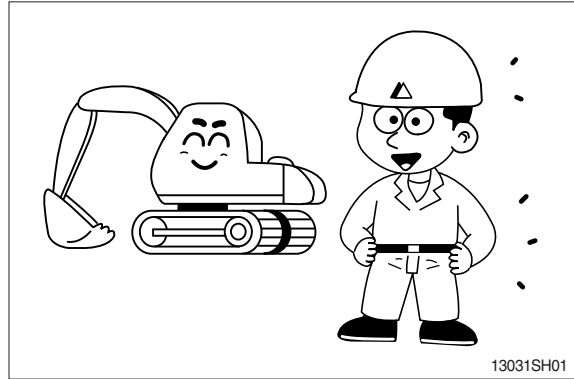

Be sure to understand thoroughly all about the operator's manual before operating the machine.

Proper care is your responsibility.

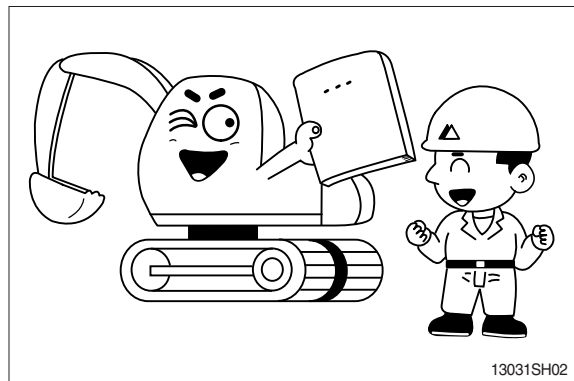

Fully understand the details and process of the construction before starting the work.

If you find anything dangerous on the job, consult with the job supervisor for the preventive measures before operating the machine.

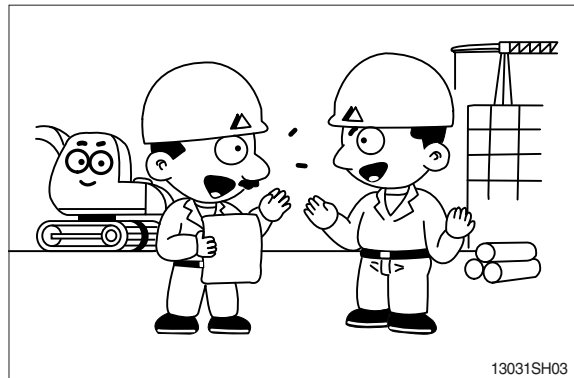

Do not operate when tired, or after drinking alcoholic beverages or any type of drugs.

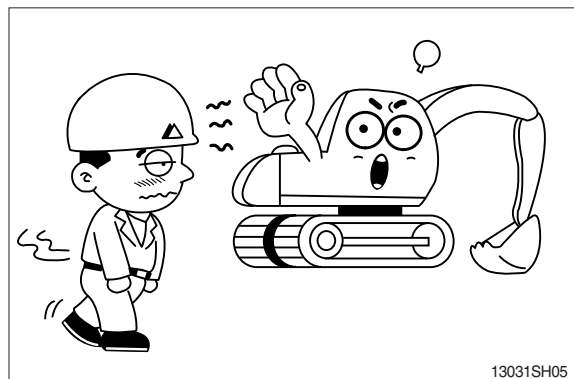

Check daily according to the operation manual.  
Repair the damaged parts and tighten the loosened bolts.

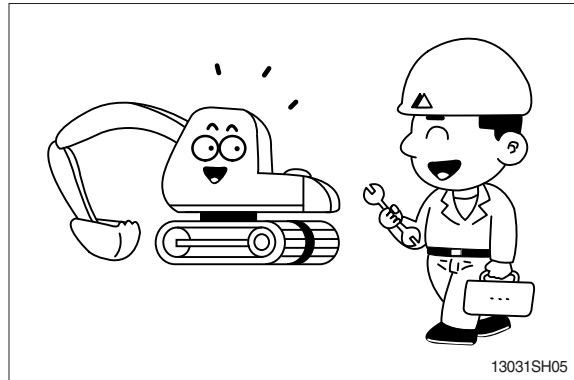

Check for leakage of engine oil, hydraulic oil, fuel and coolant.  
Keep machine clean, clean machine regularly.

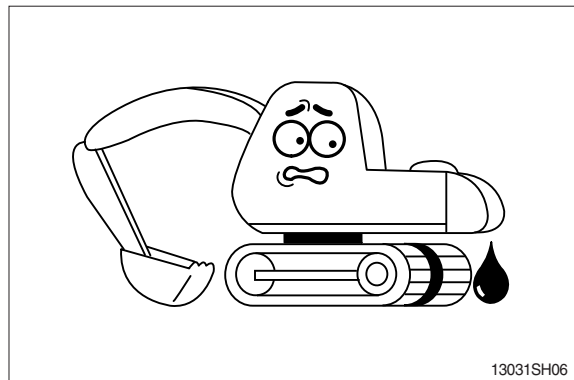

Do not operate the machine if it requires repairs.  
Operate after complete repair.

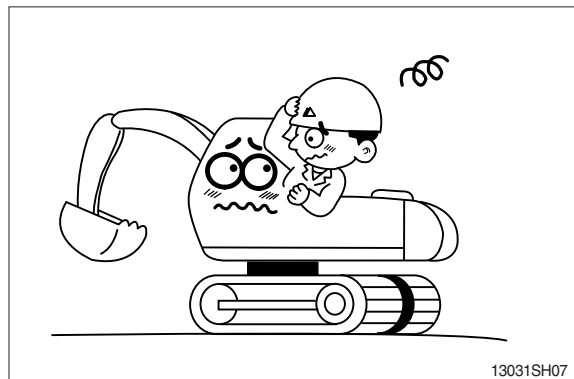

Be prepared if a fire starts.  
Keep a fire extinguisher handy and emergency numbers for a fire department near your telephone.

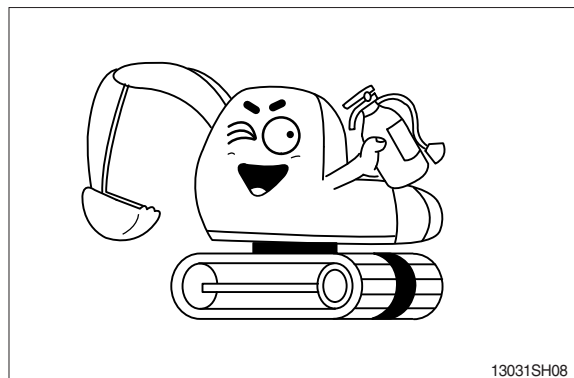

## PROTECTION AGAINST FALLING OR FLYING OBJECTS

If there is any danger of falling or flying objects hitting the operator, install protective guards in place to protect the operator as required for each particular situation.

Be sure to close the front window before commencing work.

Make sure to keep all persons other than operator outside the range of falling or flying objects.

In case you need top guard, front guard and FOPS(Falling object protective structure), please contact Hyundai distributor in Europe.

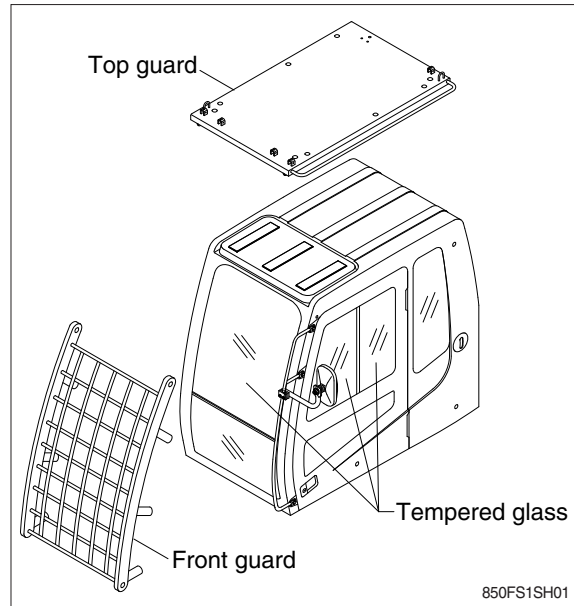

## UNAUTHORIZED MODIFICATION

Any modification made without authorization from Hyundai can create hazards.

Before making a modification, consult your Hyundai distributor. Hyundai will not be responsible for any injury or damage caused by any unauthorized modification.

## PREPARE FOR EMERGENCY

Only in case of emergency, use the installed hammer for breaking the windshield of the cab, and then exit carefully.

Have a fire extinguisher and first aid kit ready for emergencies such as fires or accidents.

Learn how to use the fire extinguisher.

Be sure you know the phone numbers of persons you should contact in case of an emergency.

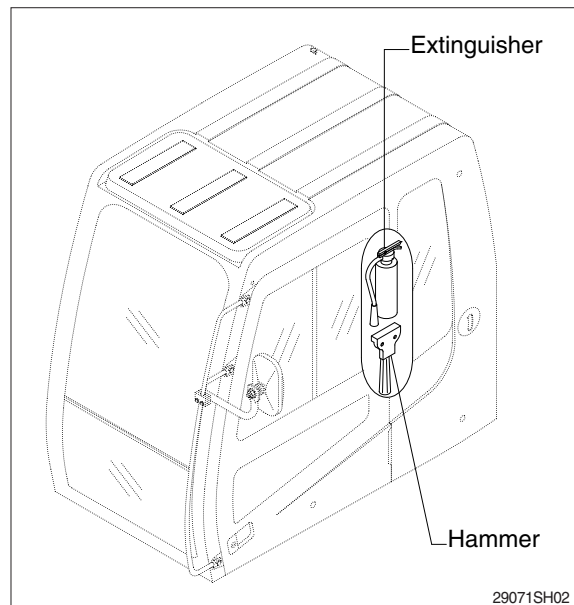

## ROTATING BEACON

When you operate a machine on a road or beside a road, a rotating beacon is required to avoid any traffic accident.

Please contact your Hyundai distributor to install it.

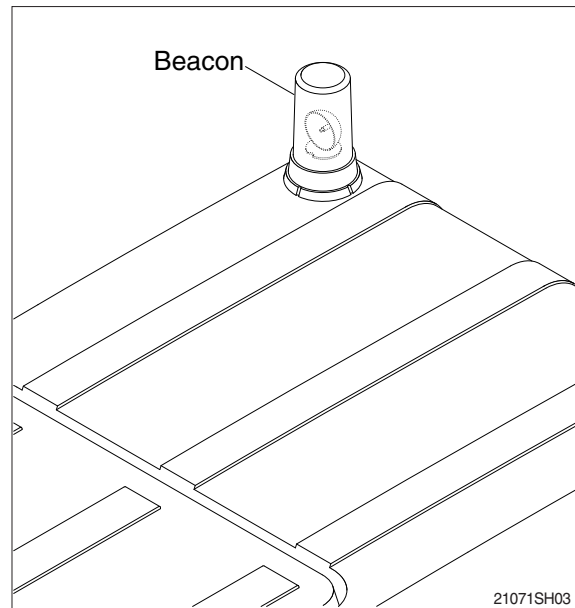

## PRECAUTIONS FOR ATTACHMENTS

When installing and using an optional attachment, read the instruction manual for the attachment and the information related to attachments in this manual.

Do not use attachments that are not authorized by Hyundai or your Hyundai distributor. Use of unauthorized attachments could create a safety problem and adversely affect the proper operation and useful life of the machine.

Any injuries, accidents, product failures resulting from the use of unauthorized attachments are not the responsibility of Hyundai.

## SAFETY RULES

**Only** trained and authorized personnel can operate and maintain the machine.

Follow all safety rules, precautions and instructions when operating or performing maintenance on the machine.

When working with another operator or a person on worksite traffic duty, be sure all personnel understand all hand signals that are to be used.

## SAFETY FEATURES

Be sure all guards and covers are in their proper position. Have guards and covers repaired if damaged.

Use safety features such as safety lock and seat belts properly.

**Never** remove any safety features. **Always** keep them in good operating condition.

Improper use of safety features could result in serious bodily injury or death.

## MACHINE CONTROL PATTERN

Check machine control pattern for conformance to pattern on label in cab.

If not, change label to match pattern before operating machine.

Failure to do so could result in injury.

## CALIFORNIA PROPOSITION 65

Diesel engine exhaust and some of its constituents are known to the State of California to cause cancer, birth defects and other reproductive harm.

This product contains or emits chemicals known to the State of California to cause cancer or birth defects or other reproductive harm.

Battery posts, terminals and related accessories contain lead and lead compounds.

WASH HANDS AFTER HANDLING

Do not load the machine with the lifting eyes on the counterweight.

**▲ The wrong loading method can result in serious bodily injury or death.**

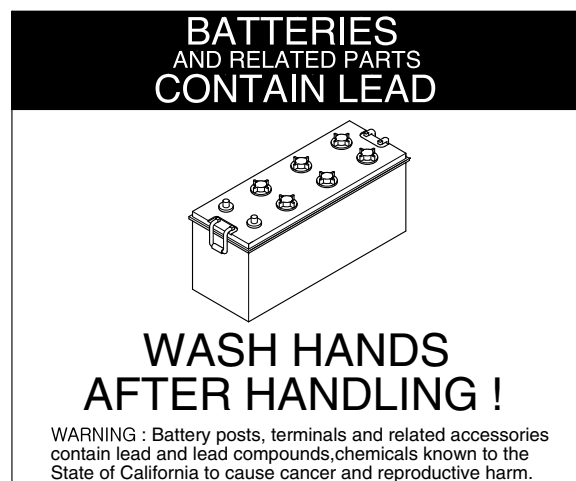

13031SH55

## FIRE PREVENTION AND EXPLOSION PREVENTION

### Regeneration

The exhaust gas temperatures during regeneration will be elevated. Follow proper fire prevention instructions and use the disable regeneration function when appropriate.

### General

All fuels, most lubricants, and some coolant mixtures are flammable.

To minimize the risk of fire or explosion, the following actions are recommended.

Always perform a Walk-Around Inspection, which may help you identify a fire hazard.

Do not operate a machine when a fire hazard exists. Contact your dealer for service.



3001SH01

Understand the use of the primary exit and alternative exit on the machine.

Do not operate a machine with a fluid leak. Repair leaks and clean up fluids before resuming machine operation. Fluids that are leaking or spilled onto hot surfaces or onto electrical components can cause a fire. A fire may cause personal injury or death.

Do not weld on or drill holes in the engine cover. Flammable material such as leaves, twigs, papers, trash may accumulate in engine compartment.

Remove flammable material such as leaves, twigs, papers, trash and so on. These items may accumulate in the engine compartment or around other hot areas and hot parts on the machine.

Keep the access doors to major machine compartments closed and access doors in working condition in order to permit the use of fire suppression equipment, in case a fire should occur.

Clean all accumulations of flammable materials such as fuel, oil, and debris from the machine.

Do not operate the machine near any flame.

Keep shields in place. Exhaust shields (if equipped) protect hot exhaust components from oil spray or fuel spray in a break in a line, in a hose, or in a seal. Exhaust shields must be installed correctly.

Do not weld or flame cut on tanks or lines that contain flammable fluids or flammable material. Empty and purge the lines and tanks. Then clean the lines and tanks with a nonflammable solvent prior to welding or flame cutting. Ensure that the components are properly grounded in order to avoid unwanted arcs.

Dust that is generated from repairing nonmetallic hoods or fenders may be flammable and/or explosive. Repair such components in a ventilated area away from open flames or sparks. Use suitable Personal Protection Equipment (PPE).

Inspect all lines and hoses for wear or deterioration. Replace damaged lines and hoses. The lines and the hoses should have adequate support and secure clamps. Tighten all connections to the recommended torque. Damage to the protective cover or insulation may provide fuel for fires.

## SAFETY FEATURES

Be sure all guards and covers are in their proper position. Have guards and covers repaired if damaged.

Use safety features such as safety lock and seat belts properly.

**Never** remove any safety features. **Always** keep them in good operating condition.

Improper use of safety features could result in serious bodily injury or death.

## MACHINE CONTROL PATTERN

Check machine control pattern for conformance to pattern on label in cab.

If not, change label to match pattern before operating machine.

Failure to do so could result in injury.

## CALIFORNIA PROPOSITION 65

Diesel engine exhaust and some of its constituents are known to the State of California to cause cancer, birth defects and other reproductive harm.

This product contains or emits chemicals known to the State of California to cause cancer or birth defects or other reproductive harm.

Battery posts, terminals and related accessories contain lead and lead compounds.

WASH HANDS AFTER HANDLING

Do not load the machine with the lifting eyes on the counterweight.

**▲ The wrong loading method can result in serious bodily injury or death.**

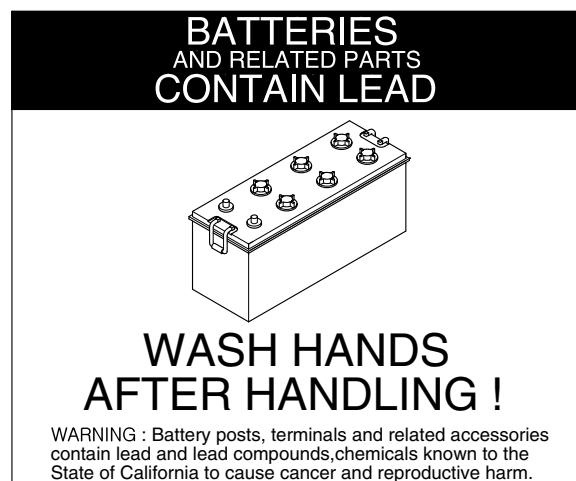

13031SH55

Store fuels and lubricants in properly marked containers away from unauthorized personnel. Store oily rags and flammable materials in protective containers. Do not smoke in areas that are used for storing flammable materials.



3001SH02

Use caution when you are fueling a machine. Do not smoke while you are fueling a machine. Do not fuel a machine near open flames or sparks. Always stop the engine before fueling. Fill the fuel tank outdoors. Properly clean areas of spillage.



Never store flammable fluids in the operator compartment of the machine.

3001SH03

### Battery and battery cables

The following actions are recommended to minimize the risk of fire or an explosion related to the battery.



3001SH04

Do not operate a machine if battery cables or related parts show signs of wear or damage. Contact your dealer for service.

Follow safe procedures for engine starting with jump-start cables. Improper jumper cable connections can cause an explosion that may result in injury.

Do not charge a frozen battery. This action may cause an explosion.

Gases from a battery can explode. Keep any open flames or sparks away from the top of a battery. Do not smoke in battery charging areas.

Never check the battery charge by placing a metal object across the terminal posts. Use a voltmeter in order to check the battery charge.

Daily inspect battery cables that are in areas that are visible. Inspect cables, clips, straps, and other restraint for damage. Replace any damaged parts. Check for signs of the following, which can occur over time due to use and environmental factors :

- Fraying
- Abrasion
- Cracking
- Discoloration
- Cuts on the insulation of the cable
- Fouling
- Corroded terminals, damaged terminals, and loose terminals



Replace damaged battery cable (s) and replace any related parts. Eliminate any fouling, which may have caused insulation failure or related component damage or wear. Ensure that all components are reinstalled correctly.

An exposed wire on the battery cable may cause a short ground if the exposed area comes into contact with a grounded surface. A battery cable short produces heat from the battery current, which may be a fire hazard.

An exposed wire on the ground cable between the battery and the disconnect switch may cause the disconnect switch to be bypassed if the exposed area comes into contact with a grounded surface. This action may result in an unsafe condition for servicing the machine. Repair components or replace components before servicing the machine.

**▲ Fire on a machine can result in personal injury or death. Exposed battery cables that come into contact with a grounded connection can result in fires. Replace cables and related parts that show signs of wear or damage. Contact your Hyundai dealer.**

## **Wiring**

Check electrical wires daily. If any of the following conditions exist, replace parts before you operate the machine.

- Fraying
- Signs of abrasion or wear
- Cracking
- Discoloration
- Cuts on insulation
- Other damage

Make sure that all clamps, guards, clips, and straps are reinstalled correctly. This action will help to prevent vibration, rubbing against other parts, and excessive heat during machine operation.

Attaching electrical wiring to hoses and tubes that contain flammable fluids or combustible fluids should be avoided.

Consult your Hyundai dealer for repair or for replacement parts.

Keep wiring and electrical connections free of debris.

## **Lines, Tubes, and Hoses**

Do not bend high-pressure lines. Do not strike high-pressure lines. Do not install any lines that are bent or damaged. Use the appropriate backup wrenches in order to tighten all connections to the recommended torque.

Check lines, tubes, and hoses carefully. Wear Personal Protection Equipment (PPE) in order to check for leaks. Always use a board or cardboard when you check for a leak. Leaking fluid that is under pressure can penetrate body tissue. Fluid penetration can cause serious injury and possible death. A pin hole leak can cause severe injury. If fluid is injected into your skin, you must get treatment immediately. Seek treatment from a doctor that is familiar with this type of injury.

Replace the affected parts if any of the following conditions are present :

- End fittings are damaged or leaking.
- Outer coverings are chafed or cut.
- Wires are exposed.
- Outer coverings are swelling or ballooning.
- Flexible parts of the hoses are kinked.
- Outer covers have exposed embedded armoring.
- End fittings are displaced.

Make sure that all clamps, guards, and heat shields are installed correctly. During machine operation, this action will help to prevent vibration, rubbing against other parts, excessive heat, and failure of lines, tubes, and hoses.

Do not operate a machine when a fire hazard exists. Repair any lines that are corroded, loose, or damaged. Leaks may provide fuel for fires. Consult your Hyundai dealer for repair or for replacement parts.

## **Ether**

Ether (if equipped) is commonly used in cold weather applications. Ether is flammable and poisonous.

Do not spray ether manually into an engine if the machine is equipped with a thermal starting aid for cold weather starting.

Use ether in ventilated areas. Do not smoke while you are replacing an ether cylinder or while you are using an ether spray.

Do not store ether cylinders in living areas or in the operator compartment of a machine. Do not store ether cylinders in direct sunlight or in temperatures above 49°C(120.2 °F). Keep ether cylinders away from unauthorized personnel.

## Fire Extinguisher

As an additional safety measure, keep a fire extinguisher on the machine.

Be familiar with the operation of the fire extinguisher. Inspect the fire extinguisher and service the fire extinguisher regularly. Follow the recommendations on the instruction plate.

Consider installation of an aftermarket Fire Suppression System, if the application and working conditions warrant the installation.

## Fire Safety

※ **Locate secondary exits and how to use the secondary exits before you operate the machine.**

※ **Locate fire extinguishers and how to use a fire extinguisher before you operate the machine.**

If you find that you are involved in a machine fire, your safety and that of others on site is the top priority. The following actions should only be performed if the actions do not present a danger or risk to you and any nearby people. At all times you should assess the risk of personal injury and move away to a safe distance as soon as you feel unsafe.

Move the machine away from nearby combustible material such as fuel/oil stations, structures, trash, mulch and timber.

Lower any implements and turn off the engine as soon as possible. If you leave the engine running, the engine will continue to feed a fire. The fire will be fed from away damaged hoses that are attached to the engine or pumps.

If possible, turn the battery disconnect switch to the OFF position. Disconnecting the battery will remove the ignition source in the event of an electrical short. Disconnecting the battery will eliminate a second ignition source if electrical wiring is damaged by the fire, resulting in a short circuit.

Notify emergency personnel of the fire and your location.

If your machine is equipped with a fire suppression system, follow the manufacturers procedure for activating the system.

※ **Fire suppression systems need to be regularly inspected by qualified personnel. You must be trained to operate the fire suppression system.**

Use the on-board fire extinguisher and use the following procedure :

1. Pull the pin.
2. Aim the extinguisher or nozzle at the base of the fire.
3. Squeeze the handle and release the extinguishing agent.
4. Sweep the extinguisher from side to side across the base of the fire until the fire is out.

Remember, if you are unable to do anything else, shut off the machine before exiting. By shutting off the machine, fuels will not continue to be pumped into the fire.

If the fire grows out of control, be aware of the following risks :

- Tires on wheeled machines pose a risk of explosion as tires burn. Hot shrapnel and debris can be thrown great distances in an explosion.
- Tanks, accumulators, hoses, and fittings can rupture in a fire, spraying fuels and shrapnel over a large area.

Remember that nearby all of the fluids on the machine are flammable, including coolant and oils. Additionally, plastics, rubbers, fabrics, and resins in fiberglass panels are also flammable.

## **Fire extinguisher Location**

Make sure that a fire extinguisher is available. Be familiar with the operation of the fire extinguisher. Inspect the fire extinguisher and service the fire extinguisher. Obey the recommendations on the instruction plate.

Mount the fire extinguisher in the accepted location per local regulations.

If your machine is equipped with a ROPS structure, strap the mounting plate to the ROPS in order to mount the fire extinguisher. If the weight of the fire extinguisher exceeds 4.5 kg (10 lb), mount the fire extinguisher near the bottom of the ROPS. Do not mount the fire extinguisher at the upper one-third area on the ROPS.

Do not weld the ROPS structure in order to install the fire extinguisher. Also, do not drill holes in the ROPS structure in order to mount the fire extinguisher on the ROPS.

Consult your Hyundai dealer for the proper procedure for mounting the fire extinguisher.

## THE EUROPEAN UNION PHYSICAL AGENTS (VIBRATION) DIRECTIVE 2002/44/EC

### Vibration Data for Earth-moving Machines

#### Information Concerning Hand/Arm Vibration Level

When the machine is operated according to the intended use, the hand/arm vibration of this machine is below 2.5 m/s<sup>2</sup>.

#### Information Concerning Whole Body Vibration Level

The highest root mean square value of weighted acceleration to which the whole body is subjected, is less than 0.5 m/s<sup>2</sup>.

This section provides vibration data and a method for estimating the vibration level for earth moving machines.

**Vibration levels are influenced by many different parameters. Many items are listed below.**

- Operator training, behavior, mode and stress
- Job site organization, preparation, environment, weather and material
- Machine type, quality of the seat, quality of the suspension system, attachments and condition of the equipment

It is not possible to get precise vibration levels for this machine. The expected vibration levels can be estimated with the information in below Table in order to calculate the daily vibration exposure. A simple evaluation of the machine application can be used.

Estimate the vibration levels for the three vibration directions. For typical operating conditions, use the average vibration levels as the estimated level. With an experienced operator and smooth terrain, subtract the Scenario Factors from the average vibration level. For aggressive operations and severe terrain, add the Scenario Factors to the average vibration level in order to obtain the estimated vibration level.

※ All vibration levels are in meter per second squared.

ISO Reference Table A – Equivalent vibration levels of whole body vibration emission for earthmoving equipment.

Machine family	Machine kind	Typical operating condition	Vibration Levels			Scenario Factors		
			X axis	Y axis	Z axis	X axis	Y axis	Z axis
Excavator	Compact crawler excavator	Excavating	0.33	0.21	0.19	0.19	0.12	0.10
		Hydraulic breaker app.	0.49	0.28	0.36	0.20	0.13	0.17
		Transfer movement	0.45	0.39	0.62	0.17	0.18	0.28
	Crawler excavator	Excavating	0.44	0.27	0.30	0.24	0.16	0.17
		Hydraulic breaker app.	0.53	0.31	0.55	0.30	0.18	0.28
		Mining application	0.65	0.42	0.61	0.21	0.15	0.32
		Transfer movement	0.48	0.32	0.79	0.19	0.20	0.23
	Wheeled excavator	Excavating	0.52	0.35	0.29	0.26	0.22	0.13
Transfer movement		0.41	0.53	0.61	0.12	0.20	0.19	

ISO Reference Table A – Equivalent vibration levels of whole body vibration emission for earthmoving equipment.

Machine family	Machine kind	Typical operating condition	Vibration Levels			Scenario Factors		
			X axis	Y axis	Z axis	X axis	Y axis	Z axis
Loader	skid steer loader (tracks)	V-shaped motion	1.21	1.00	0.82	0.30	0.84	0.32
	Wheel backhoe loader	Excavating	0.28	0.26	0.20	0.09	0.16	0.06
	Wheel loader	Load and carry motion	0.84	0.81	0.52	0.23	0.20	0.14
		Mining application	1.27	0.97	0.81	0.47	0.31	0.47
		Transfer movement	0.76	0.91	0.49	0.33	0.35	0.17
		V-shape motion	0.99	0.84	0.54	0.29	0.32	0.14

※ Refer to “ISO/TR 25398 Mechanical Vibration-Guideline for the assessment of exposure to whole body vibration of ride on operated earthmoving machines” for more information about vibration. This publication uses data that is measured by international institutes, organizations and manufacturers. This document provides information about the whole body exposure of operators of earthmoving equipment.

## **Guidelines for Reducing Vibration Levels on Earthmoving Equipment**

Properly adjust machines. Properly maintain machines. Operate machines smoothly. Maintain the conditions of the terrain. The following guidelines can help reduce the whole body vibration level :

1. Use the right type and size of machine, equipment, and attachments.
2. Maintain machines according to the manufacturer's recommendations.
  - a. Tire pressures
  - b. Brake and steering systems
  - c. Controls, hydraulic system and linkages
3. Keep the terrain in good condition.
  - a. Remove any large rocks or obstacles.
  - b. Fill any ditches and holes.
  - c. Provide machines and schedule time in order to maintain the conditions of the terrain.
4. Use a seat that meets "ISO 7096". Keep the seat maintained and adjusted.
  - a. Adjust the seat and suspension for the weight and the size of the operator.
  - b. Inspect and maintain the seat suspension and adjustment mechanisms.
5. Perform the following operations smoothly.
  - a. Steer
  - b. Brake
  - c. Accelerate
  - d. Shift the gears.
6. Move the attachments smoothly.
7. Adjust the machine speed and the route in order to minimize the vibration level.
  - a. Drive around obstacles and rough terrain.
  - b. Slow down when it is necessary to go over rough terrain.
8. Minimize vibrations for a long work cycle or a long travel distance.
  - a. Use machines that are equipped with suspension systems.
  - b. Use the ride control system on machines.
  - c. If no ride control system is available, reduce speed in order to prevent bounce.
  - d. Haul the machines between workplaces.
9. Less operator comfort may be caused by other risk factors. The following guidelines can be effective in order to provide better operator comfort:
  - a. Adjust the seat and adjust the controls in order to achieve good posture.
  - b. Adjust the mirrors in order to minimize twisted posture.
  - c. Provide breaks in order to reduce long periods of sitting.
  - d. Avoid jumping from the cab
  - e. Minimize repeated handling of loads and lifting of loads.
  - f. Minimize any shocks and impacts during sports and leisure activities.

## **Sources**

The vibration information and calculation procedure is based on "ISO/TR 25398 Mechanical Vibration-Guideline for whole body vibration exposure of operators of earthmoving equipment. The method is based on measured vibration emission under real working conditions for all machines.

You should check the original directive. This document summarizes part of the content of the applicable law. This document is not meant to substitute the original sources. Other parts of these documents are based on information from the United Kingdom Health and Safety Executive.

## 2. DURING OPERATING THE MACHINE

Use the handle and footstep when getting on or off the machine.

Do not jump on or off the machine.

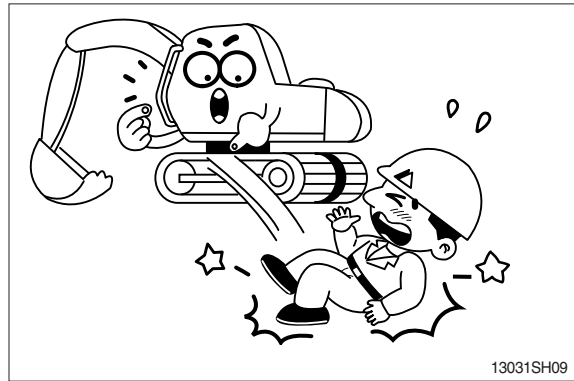

Sound the horn to warn nearby personnel before operating the machine.

Remove all the obstacles like frost on the window before operating the machine for the good visibility.

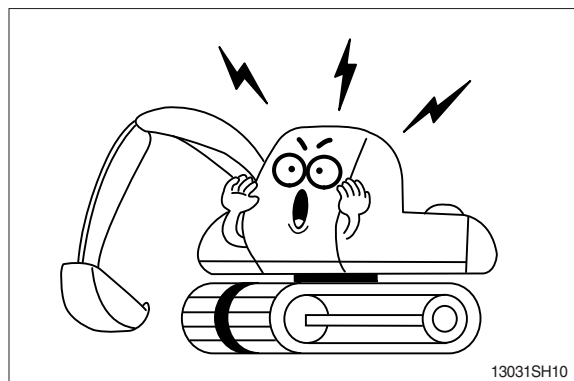

Operate carefully to make sure all personnel or obstacles are clear within the working range of the machine.

Place safety guards if necessary.

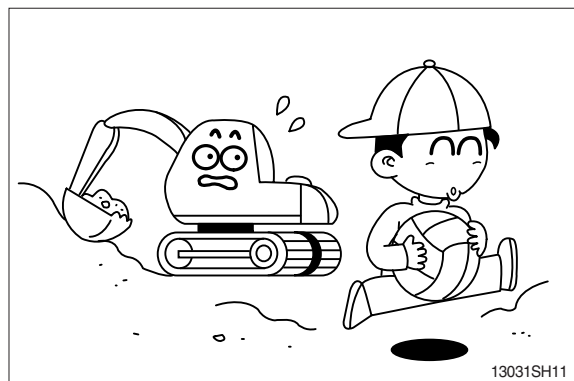

When using the work equipment, pay attention to job site.

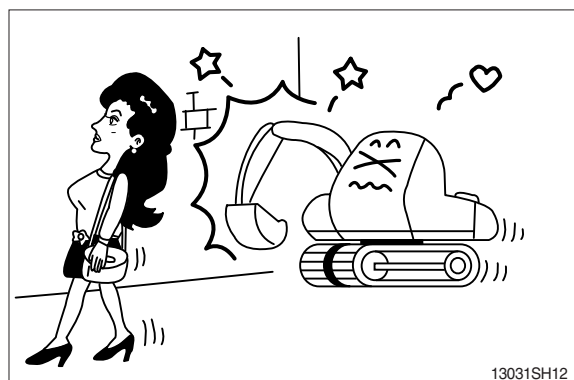



Provide proper ventilation when operating engine in a closed area to avoid the danger of exhaust gases.

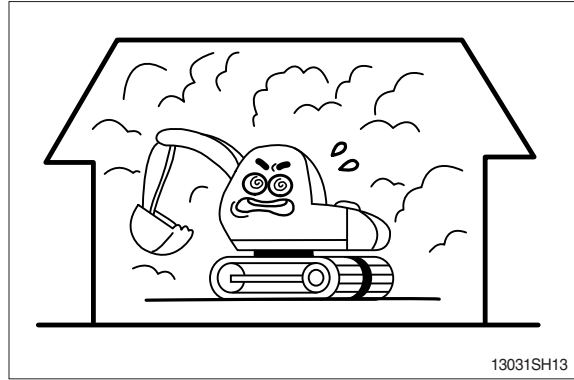

13031SH13

Check the locations of underground gas pipes or water line and secure the safety before operation.

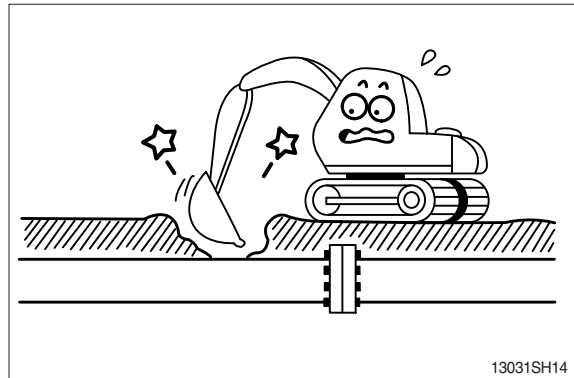

13031SH14

The operating near the electrical lines is very dangerous. Operate within safe working range permitted as below.

Supply voltage	Min safe separation
6.6 kV	3 m (10 ft)
33.0 kV	4 m (13 ft)
66.0 kV	5 m (16 ft)
154.0 kV	8 m (26 ft)
275.0 kV	10 m (33 ft)

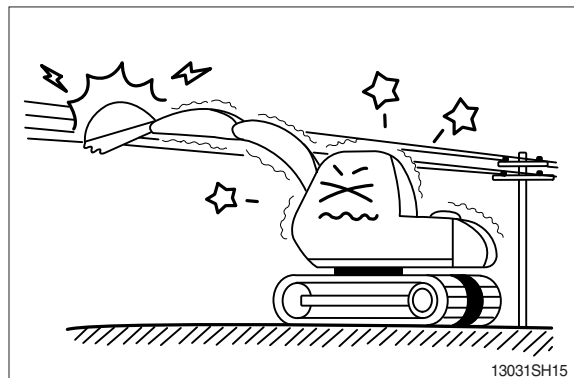

13031SH15

If the machine touches the electric power lines, keep sitting on the operator's seat and make sure the personnel on the ground not to touch the machine until turning off the electric current. Jump off the machine without contacting the machine when you need to get off.

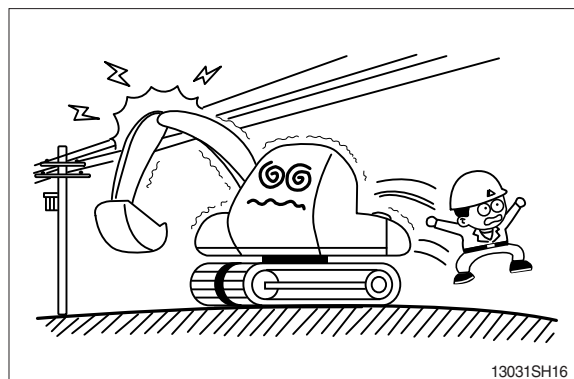

13031SH16

Watch out for obstacles.  
Be particularly careful to check the machine clearance during the swing.

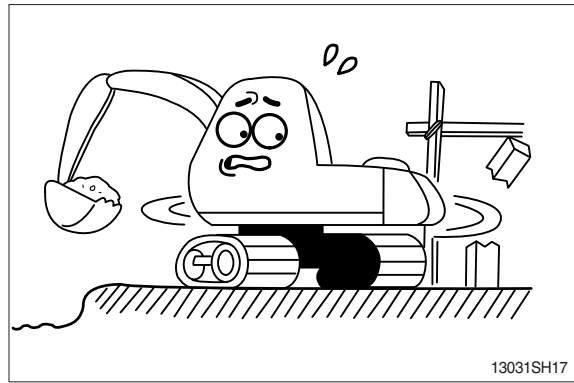

When using the machine as breaker or working in a place where stones may fall down, cab roof guard and head guard should be provided for proper protection.

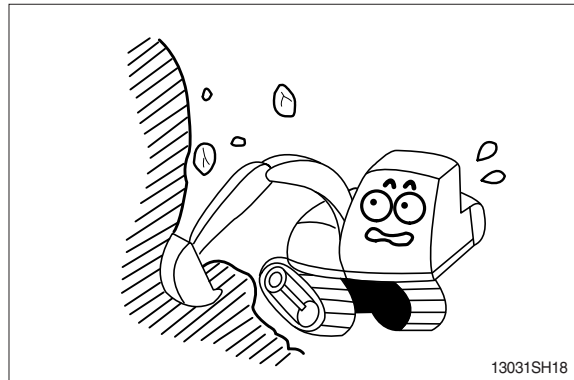

Avoid operating on a cliff or soft ground as there is danger of rolling over.  
Make sure to get off easily as keeping the track at a right angle and putting the travel motor into the backward position when working on a cliff or soft ground inevitably.

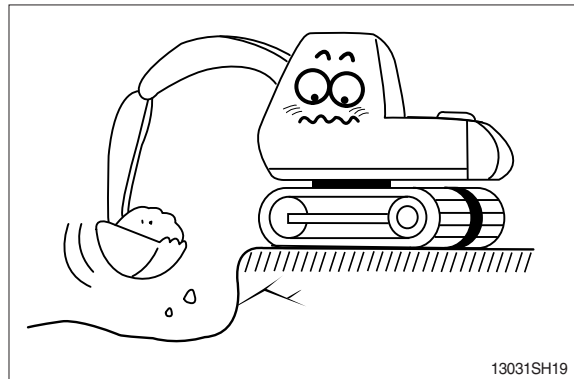

Operate for the lifting work considering the capacity of machine, weight and width of the load.  
Be careful not to lift exceeding the machine capacity as it can be the cause of machine damage and safety accident.

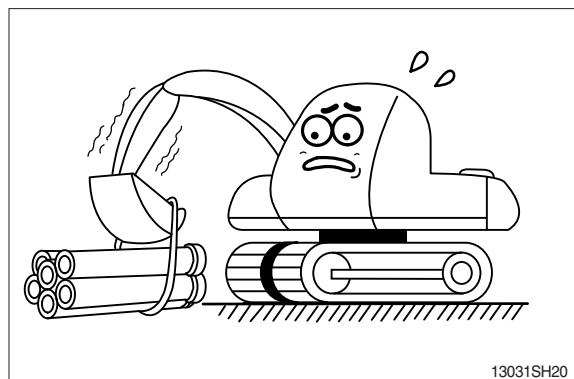

The operation on a slope is dangerous.  
Avoid operating the machine on a slope of over 10 degree.

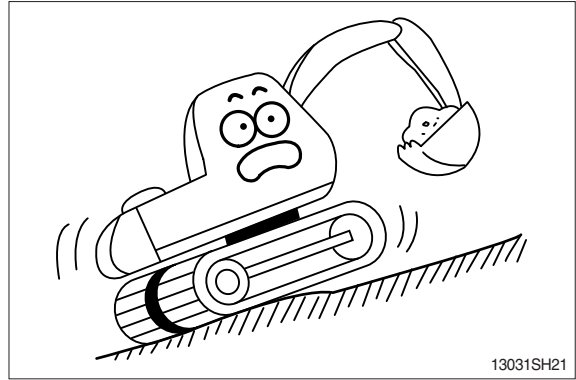

Operate the machine after making ground flat when operation is required on a slope.

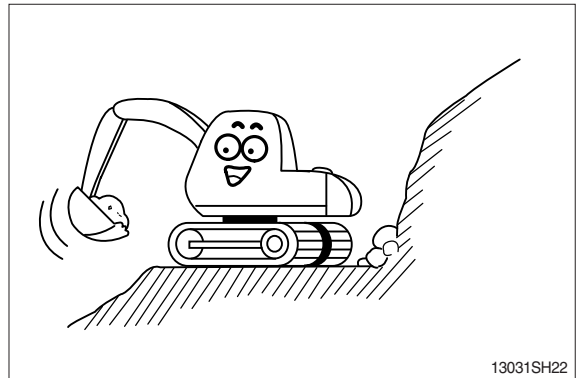

The swing on the slope can be danger of rolling over.  
Do not operate to swing the machine with the bucket loaded on a slope since the machine may lose its balance under such an instance.

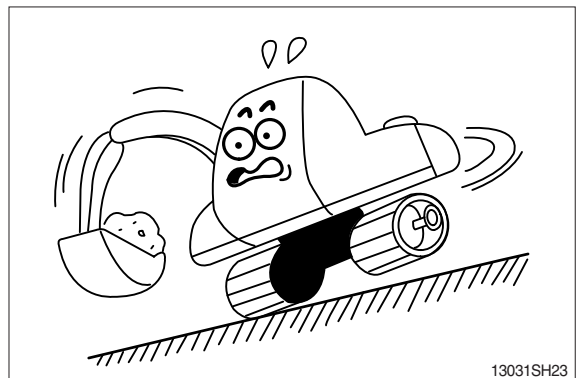

Avoid parking and stopping on a slope.  
Lower the bucket to the ground and block the track when parking.

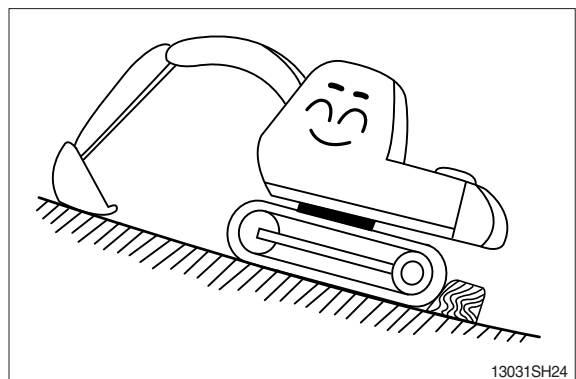

Avoid traveling in a cross direction on a slope as it can cause the danger of rolling over and sliding.

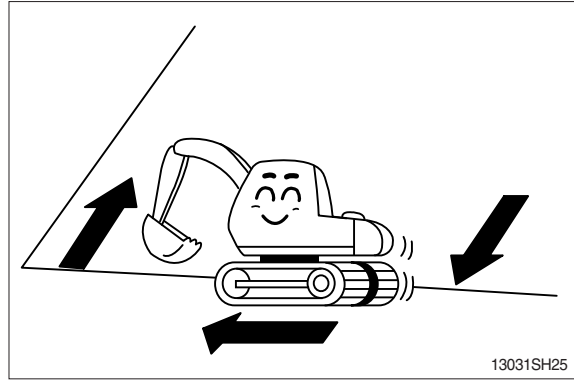

Traveling on a slope is dangerous. Be sure to operate slowly when traveling down a slope and maintain the bucket at a height of 20~30 cm (1 ft) above the ground so that it can be used as brake in an emergency.

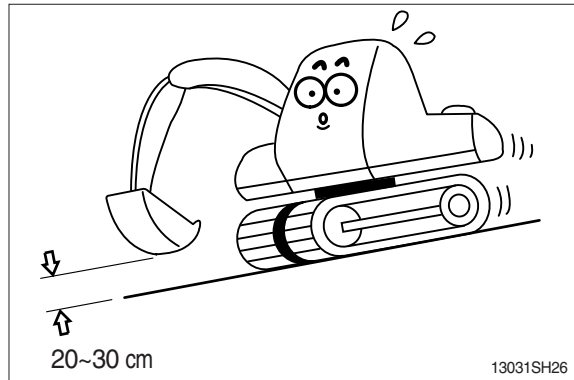

Steering of the machine while traveling on a slope is dangerous. When an inevitable turning of direction is required, turn on the flat and solid ground.

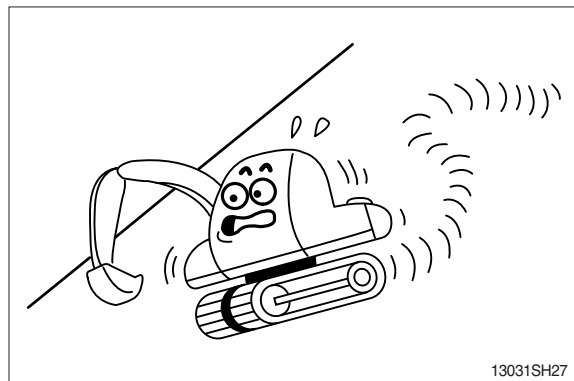

The engine angularity limits are 35 degree. Do not operate by more than the engine limits in any case.

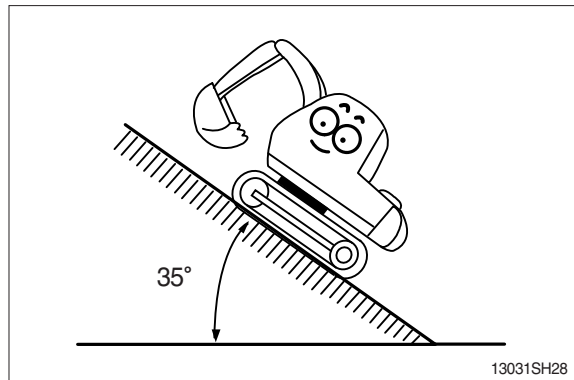

Before traveling the machine, sound the horn to warn nearby personnel.  
Operate forward and backward correctly with confirming the location of the travel motor.

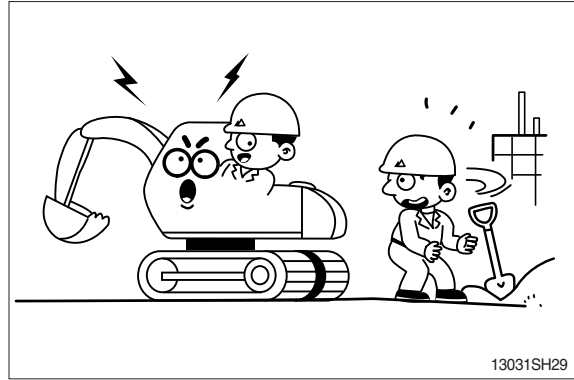

Slow down when traveling through obstacles or uneven ground.

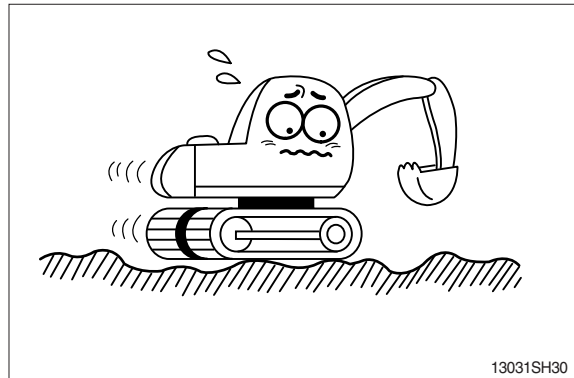

When working on soft ground, place mats or wood boards on the ground to prevent the machine sinking.

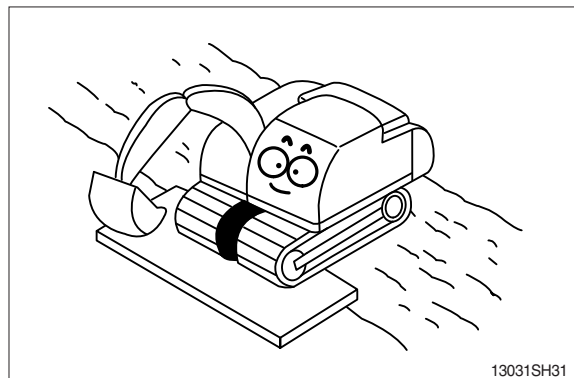

When operating in water or when crossing shallow, check the bed soil condition and depth and flow speed of water, then proceed taking care that water is not above carrier roller.

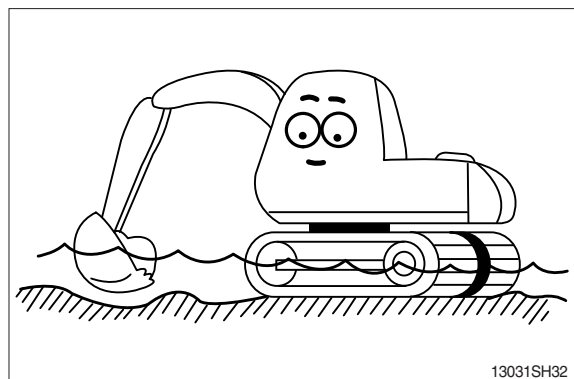

Do not retract the track gauge except transporting purpose.

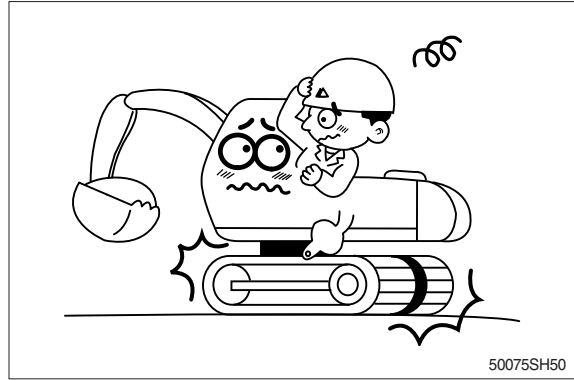

## MOUNTING AND DISMOUNTING

**Never** jump on or off the machine. **Never** get on or off a moving machine.

When mounting or dismounting, always face the machine and use the handrails, machine or track frame steps, and track shoes. Additional track frame step can be fitted for wider optional shoe. In this case please contact your Hyundai distributor.

Do not hold any control levers when getting on or off the machine.

Ensure safety by always maintaining at least three-point contact of hands and feet with the handrails, steps or track shoes.

Always remove any oil or mud from the handrails, steps and track shoes. If they are damaged, repair them and tighten any loose bolts.

If grasping the door handrail when mounting or dismounting or moving on the track, open and lock the door securely in the open position. Otherwise, the door may move suddenly, causing you to lose balance and fall.

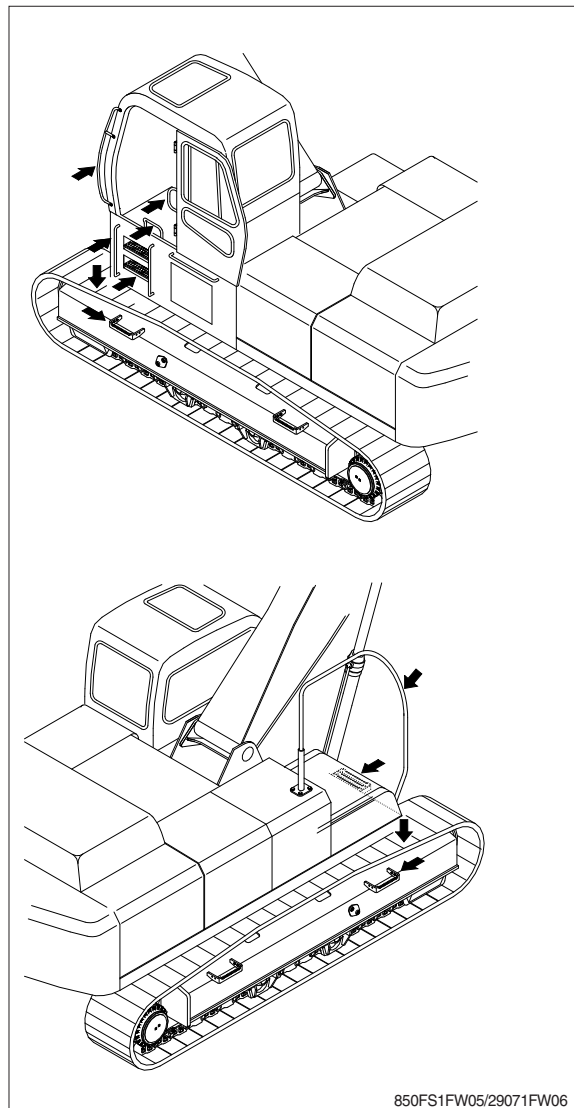

## KEEP RIDERS OFF MACHINE

Riders on a machine are subject to injury such as being struck objects and being thrown off the machine.

Only allow the operator on the machine. Keep riders off.

Never swing the upper structure when the track distance (A) is reduced since it can cause damage of machine such as track and auto grease system.

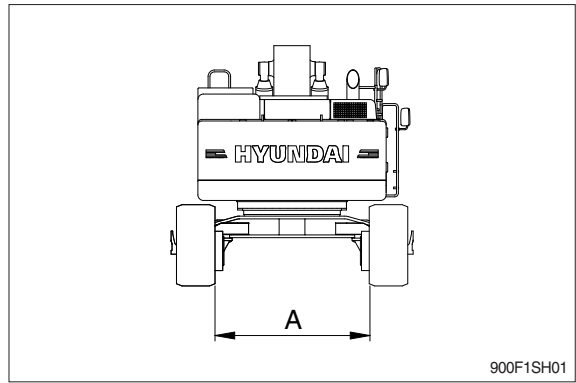

### 3. DURING MAINTENANCE

Stop the engine immediately when the trouble of the machine is found.

Inspect immediately the cause of trouble such as vibration, overheating and trouble in the cluster then repair.

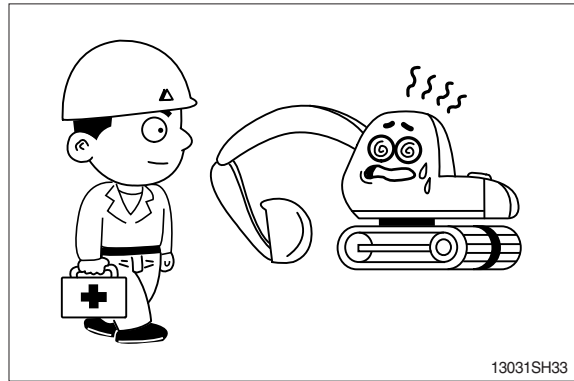

Park on a flat place and stop the engine for inspecting and repairing. Properly TAG machine is not operational. (remove start key)  
Extreme care shall be taken during maintenance work. Parts may require additional safe guard.

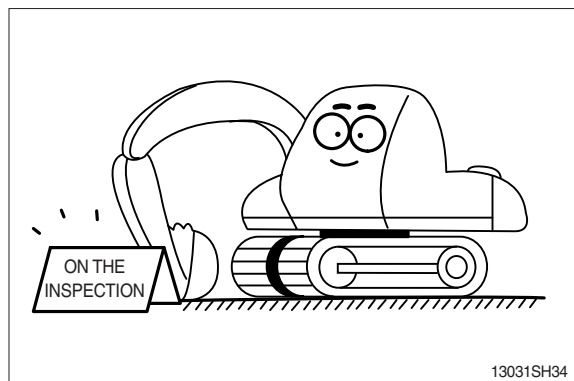

Do not remove the radiator cap from hot engine. Open the cap after the engine cools, below 50 °C (122 °F) to prevent personal injury from heated coolant spray or steam.

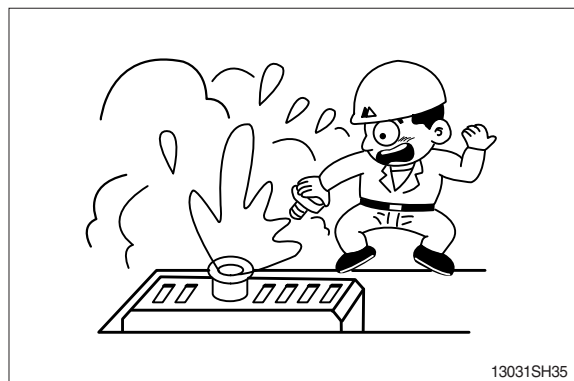

Do not work below the machine.  
Be sure to work with proper safety supports.  
Do not depend on the hydraulic cylinders to hold up the equipment and attachment.

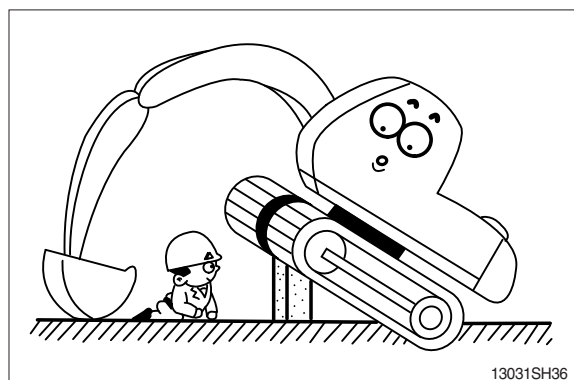



There is the danger of fire in fuel and oil.  
Store in cool and dry area, away from any open flames.

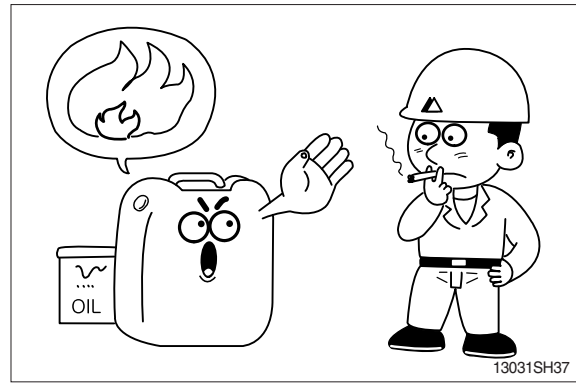

Do not touch exhaust pipe, or may cause severe burn.

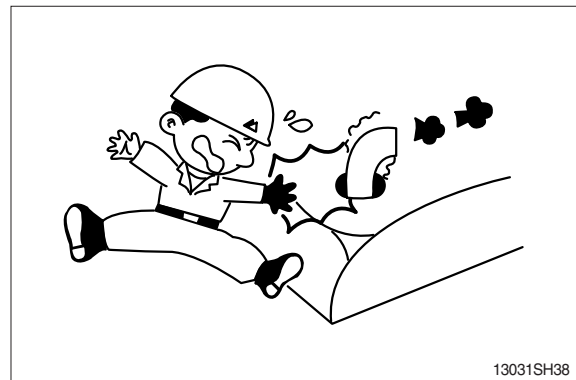

Do not open the engine hood and covers while the engine is running.



Be careful of not hitting the edges when you service engine.

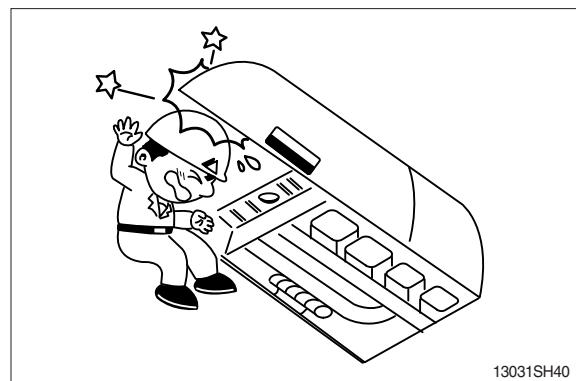

Be careful that the front window may be promptly closed.

Be sure to support stay, when the side door needs to be opened.

Be careful that the open side door may closed by the external or natural force like strong wind.

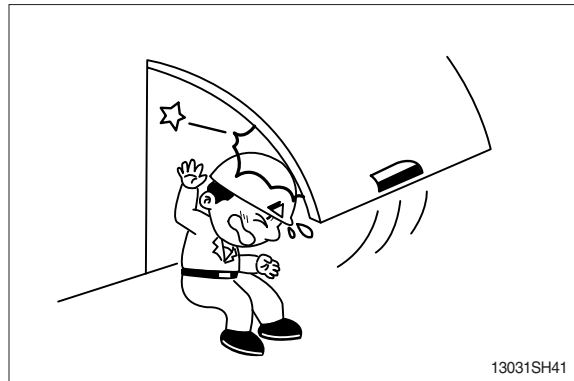

The antislip protection should be replaced if they have become worn or have been printed over.

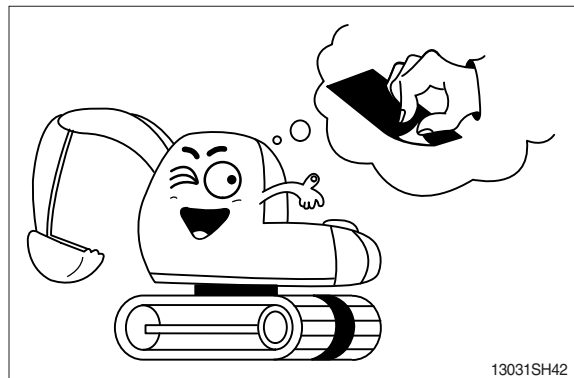

Be careful of not touching slip, fall down etc., when you work at the upper frame to service engine and/or other component.

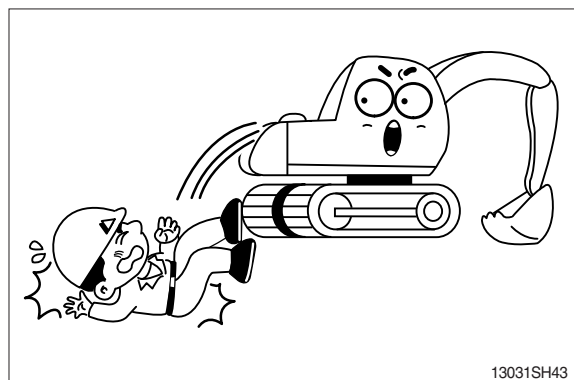

### HIGH PRESSURE GAS

Contain high pressure gas.

To avoid explosion and personal injury, do not expose to fire, do not weld, do not drill.

Relieve pressure before discharging.

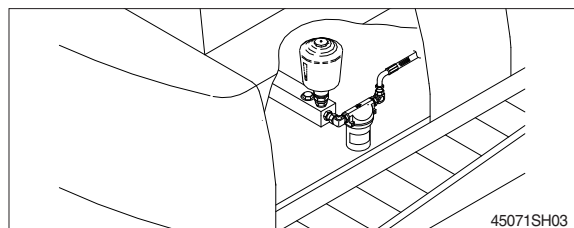

### LIFT EYES CAN FAIL

Lift eyes or tank can fail when lifting tank containing fluids resulting in possible personal injury.

Drain tank of all fluids before lifting.

## 4. PARKING

When leaving the machine after parking, lower the bucket to the ground completely and put the safety lever at parking position then remove the key.  
Lock the cab door.

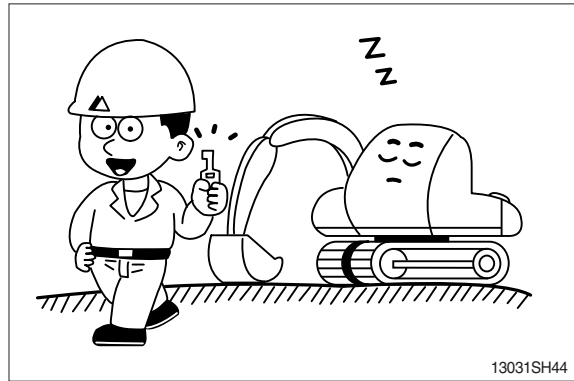

Park the machine in the flat and safe place.

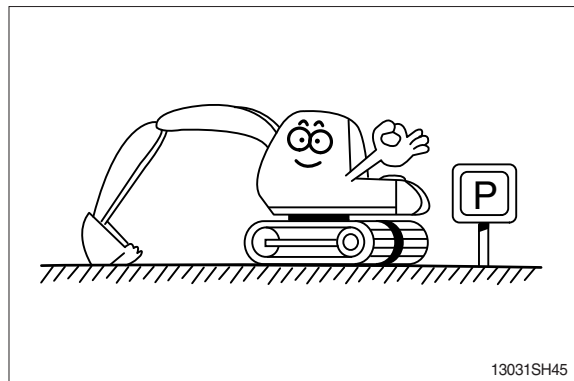

Hope you can work easily and safely observing safety rules.  
For safe operation, observe all safety rules.

